

Digital television

COFDM / ATSC

- ATSC / DTV
 - Standards
 - Broadcasting
 - 8/16-VSB
- Some comparisons
 - Tests in Australia

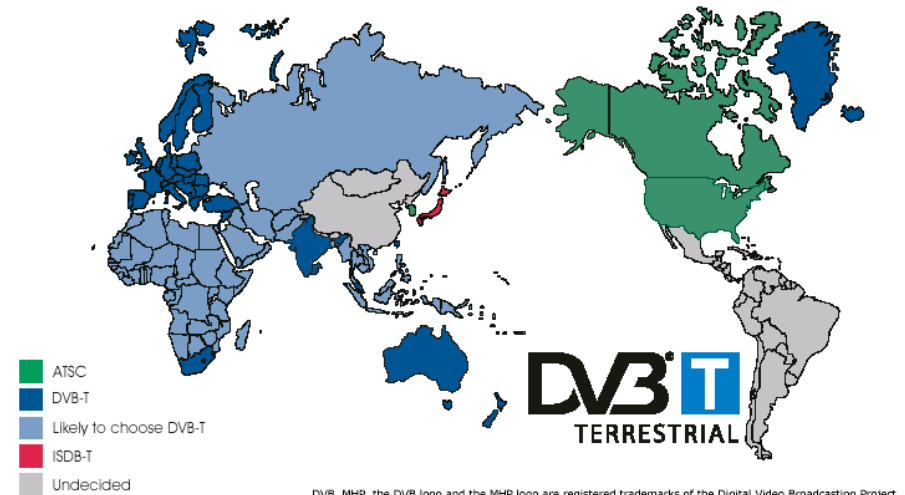

ATSC

- Advanced Television Systems Committee
- Started May 1983
- Explore the need for and coordinate national technical standards for Advanced Television
- Generation, distribution and reception of enhanced TV and HDTV
- Members: ABC, CBS, Televisia (Mexico), Sun, TI, Zenith, Dolby Lab, Eastman Kodak, Sony MIT
- ATSC Standards
- ATSC Recommended practice

ATSC

- CBS: 1080 i (1080 lines interlaced)
- ABC, NBC, FOX: 720P
- Schedule
 - Analog stops after 2006

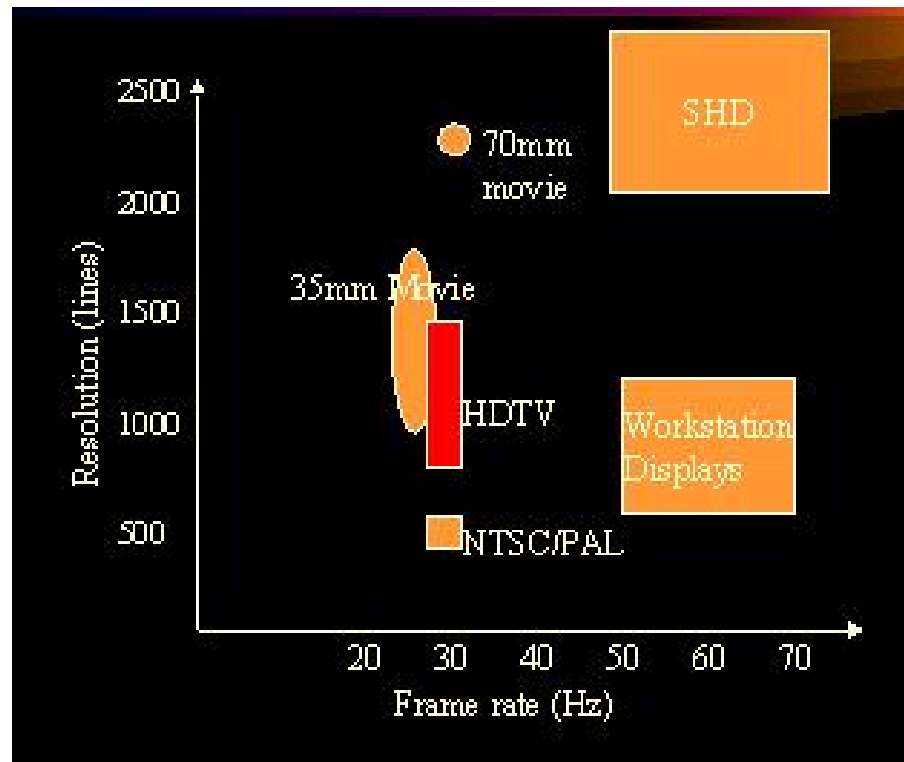

ATSC

Some standards by ATSC

- A/53B Digital Television Standard (DTV)
- A/52A Digital Audio Compression AC-3
- A/65A Program and System Information Protocol
- A/70 Conditional Access System
- A/80 Modulation and Coding for DTV over Satellite
- A/90 Data Broadcast Standard

Digital Television Standard

- High quality video over a 6 MHz channel
- 19 Mbit/s terrestrial broadcasting
- 38 Mbit/s cable broadcasting
- Video: MPEG-2, Audio: AC-3

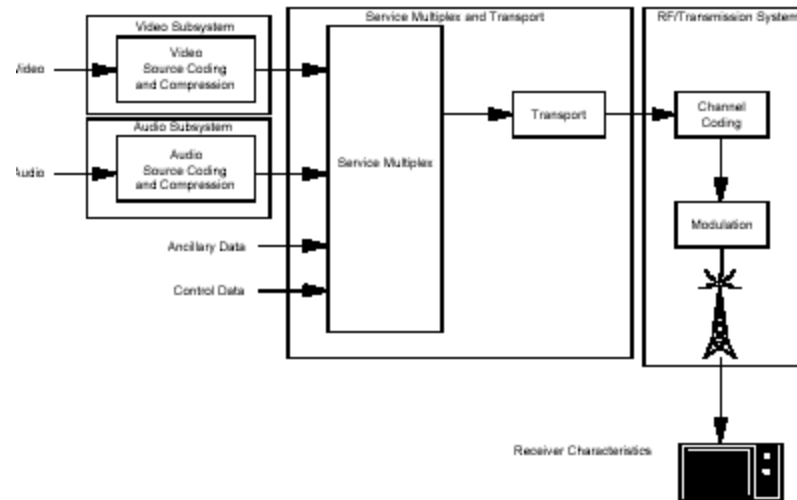

Digital Television Standard

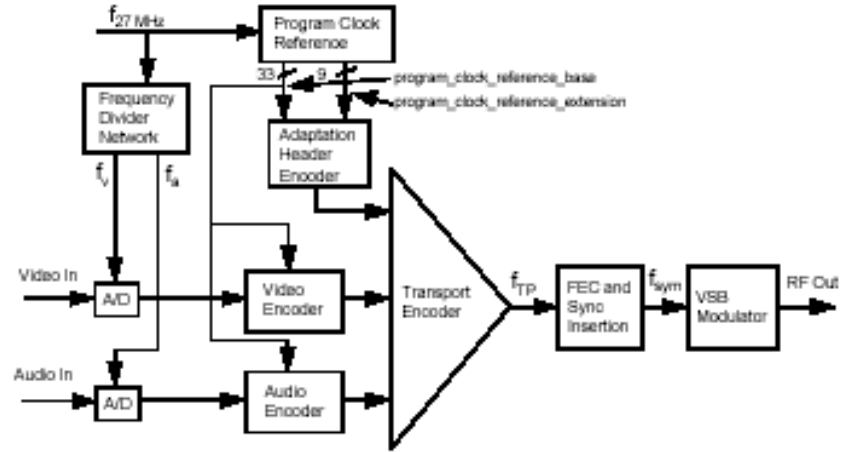

DTV – Video formats

Table A1 Standardized Video Input Formats

Video Standard	Active Lines	Active Samples/ Line
SMPTE 274M	1080	1920
SMPTE 296M	720	1280
ITU-R BT.601-4	483	720

Table A3 Compression Format Constraints

vertical_size_value	horizontal_size_value	aspect_ratio_information	frame_rate_code	progressive_sequence
1080 ⁱ	1920	1,3	1,2,4,5	1
			4,5	0
720	1280	1,3	1,2,4,5,7,8	1
480	704	2,3	1,2,4,5,7,8	1
			4,5	0
	640	1,2	1,2,4,5,7,8	1
			4,5	0
Legend for MPEG-2 coded values: aspect_ratio_information: 1 = square samples, 2 = 4:3 display aspect ratio, 3 = 16:9 display aspect ratio frame_rate_code: 1 = 23.976 Hz, 2 = 24 Hz, 4 = 29.97 Hz, 5 = 30 Hz, 7 = 59.94 Hz, 8 = 60 Hz progressive_sequence: 0 = interlaced scan, 1 = progressive scan				

DTV – Multiplex

- ISO/IEC 13818-1 – Fixed-length packet transport
- Multiplexes are identified using PID
- PES – Packetized Elementary Stream – Encapsulated Video and Audio stream

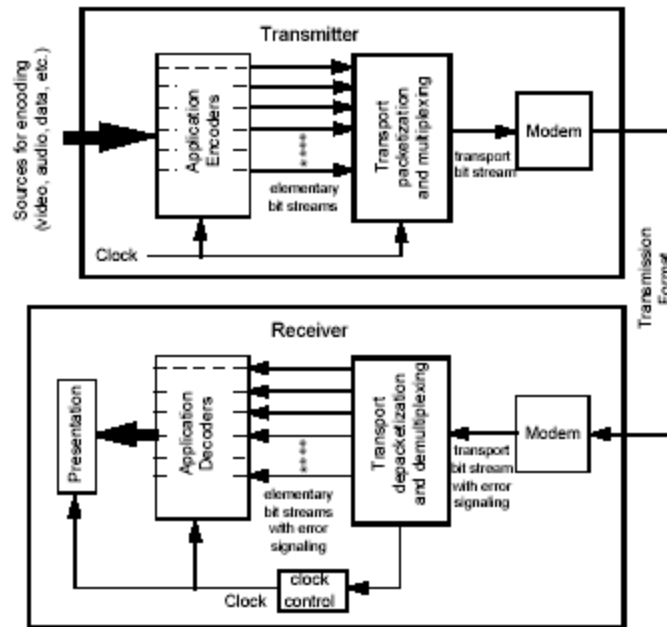

DTV – RF/Transmission system

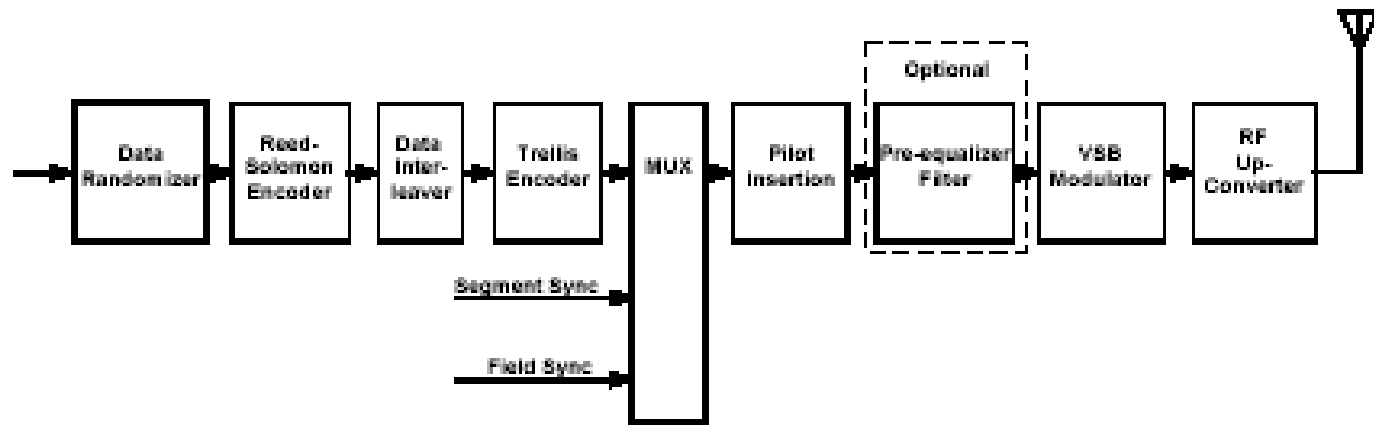

Encoded transport packet size:

187 data bytes + 20 RS parity bytes = 207 bytes

207 bytes · 8 bits/byte = 1656 bits

2/3 rate convolutional coding requires $\frac{3}{2} \cdot 1656$ bits = 2484 bits

DTV – RF/Transmission system

Data organization for transmission:

Frame: 2 data fields

Data field: 313 segments

Segments: 828 symbols

(828 x 8 bits = 2484 bits)

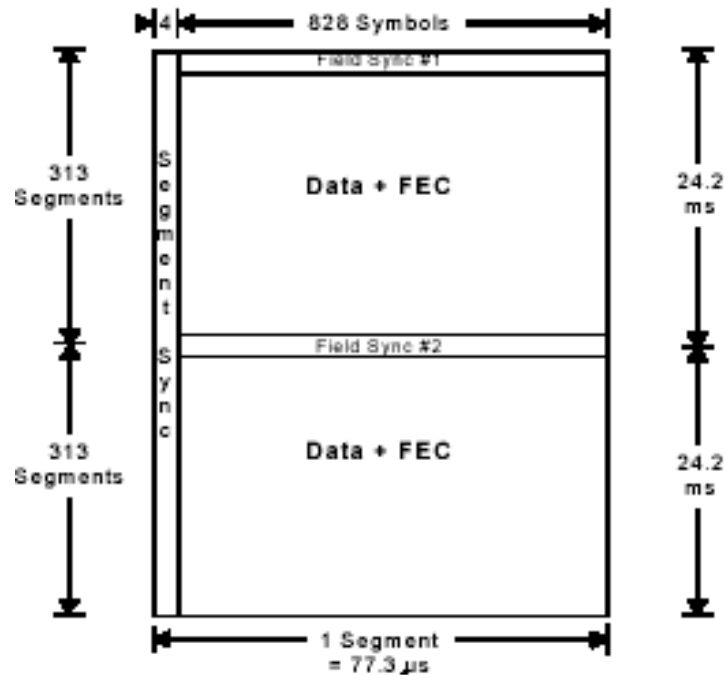

DTV – Data Randomizer

Generator Polynomial $G_{(16)} = X^{16} + X^{13} + X^{12} + X^{11} + X^7 + X^6 + X^3 + X + 1$

The initialization (pre load) occurs during the field sync interval

Initialization to F180 hex (Load to 1)
 $X^{16} X^{15} X^{14} X^{13} X^9 X^8$

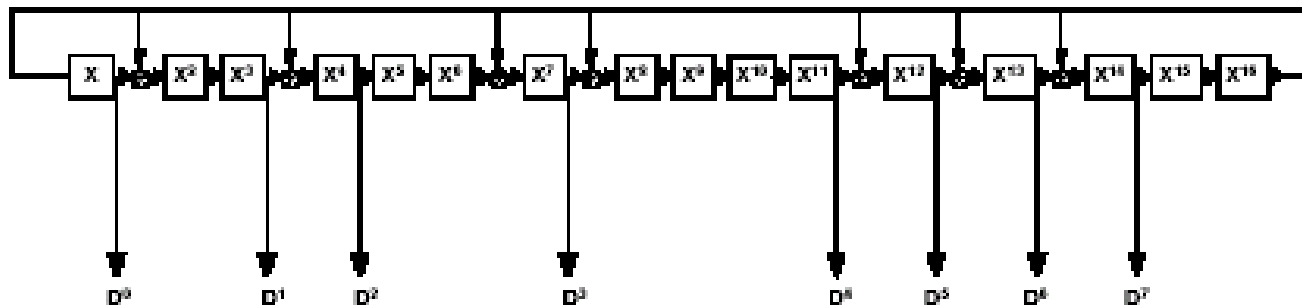

DTV – Reed Solomon, interleaving

- Reed solomon encoder RS(207,187)
 - (compare DVB-T RS(204,188))
- Byte interleaver:

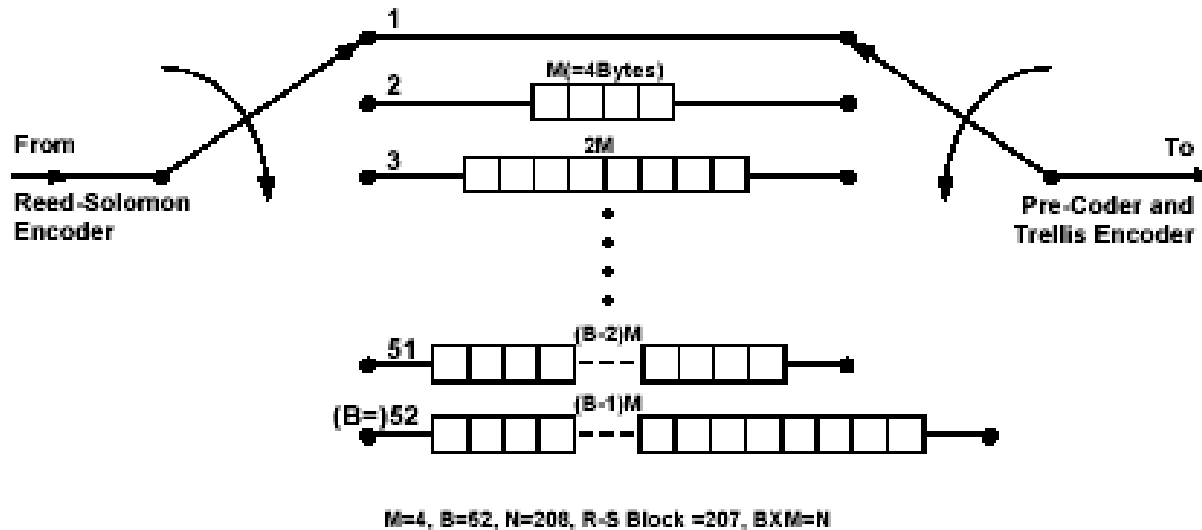

DTV – Trellis encoding

2/3 rate trellis code, mapped into 8 levels

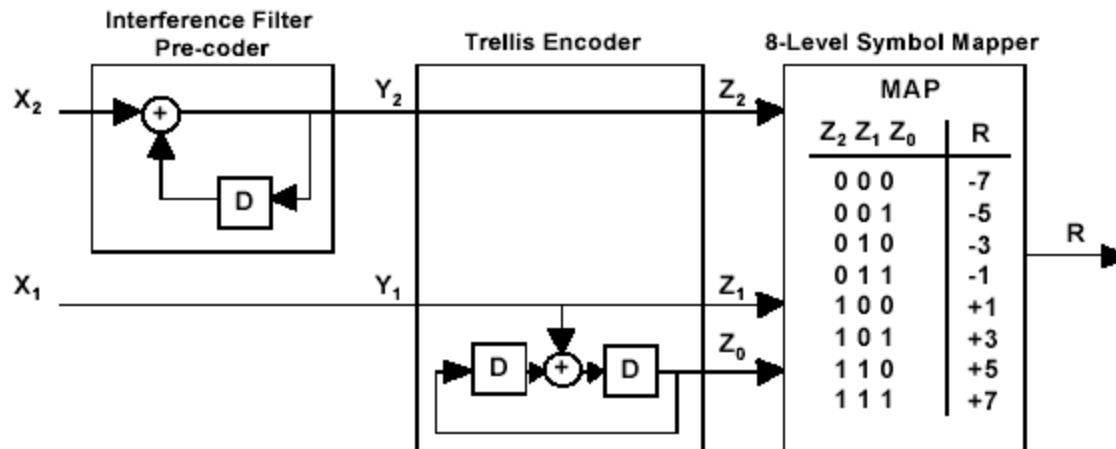

$D = 12$ symbols delay

DTV – VSB Data segments

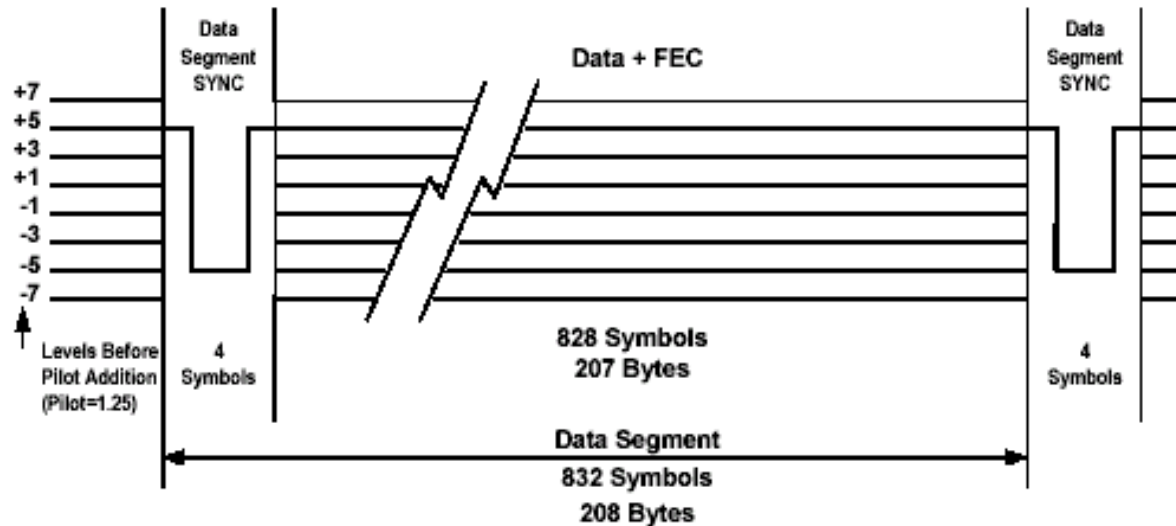

Sync: 4 symbols of 2 levels = {1 0 0 1}

DTV – Data Field sync

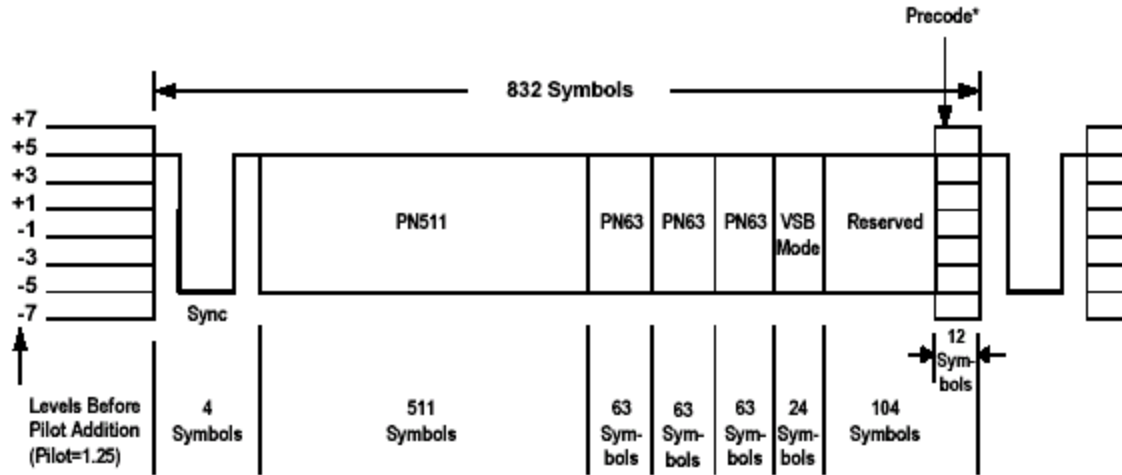

* For trellis coded terrestrial 8 VSB the last 12 symbols of the previous segment are duplicated in the last 12 reserved symbols of the field sync.

4 symbol sync = { 1 0 0 1 }

PN511: Pseudo random signal

PN63: Pseudo random signal

VSB mode: 8-VSB or 16-VSB

DTV – 16 VSB

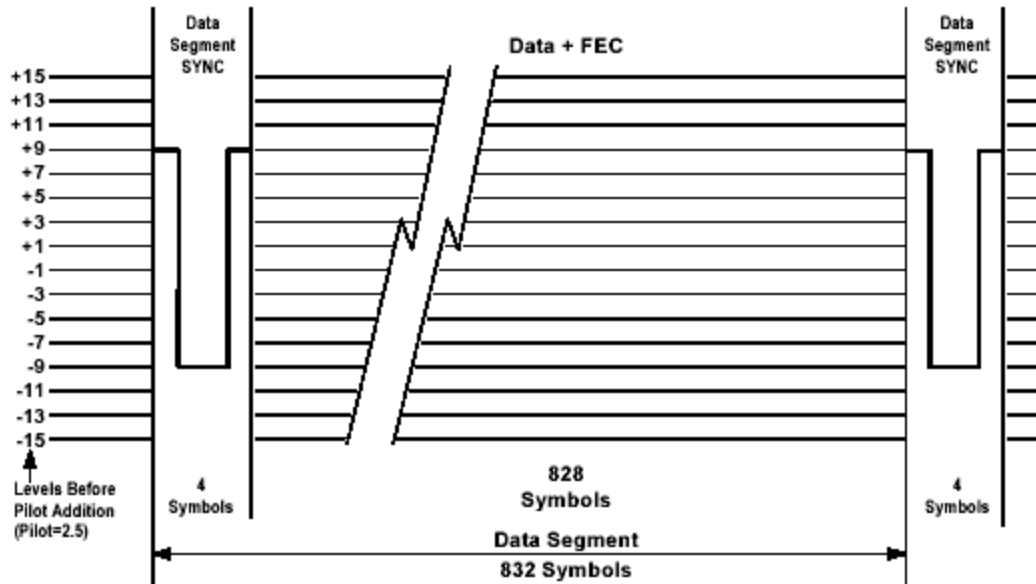

DTV – 16 VSB

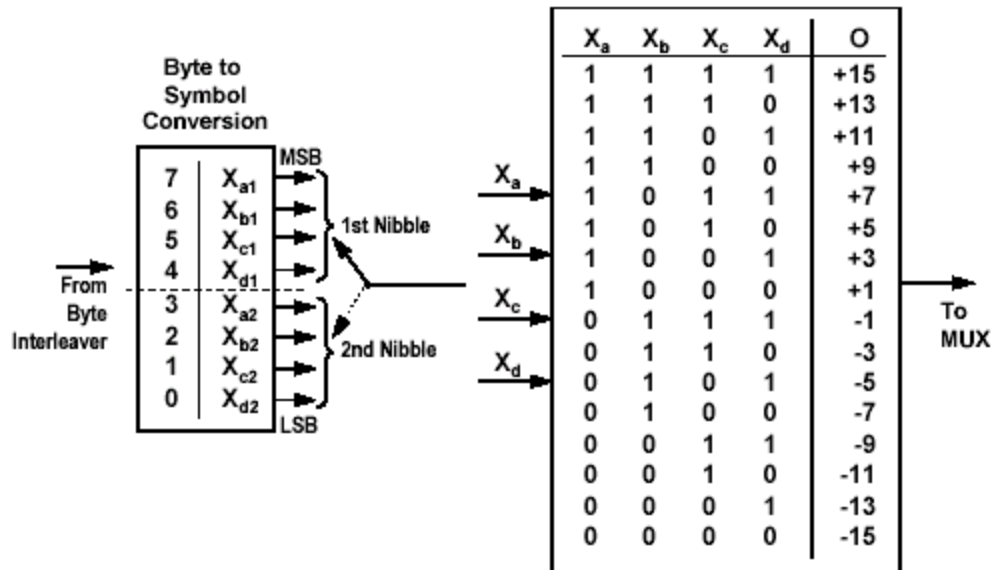
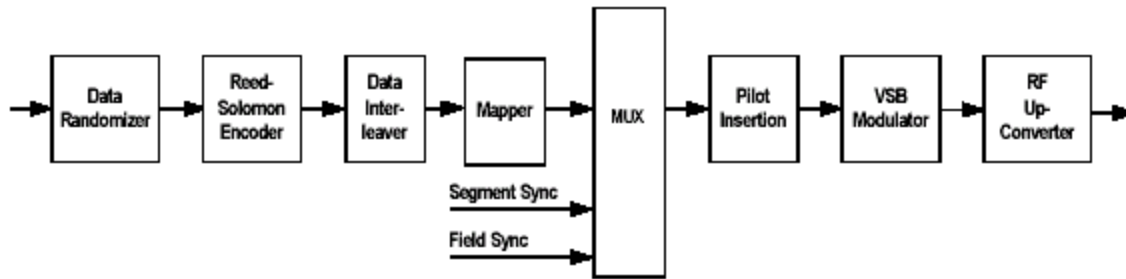

DTV – VSB Modulation

- 8-VSB – Amplitude modulation with 8 amplitude levels

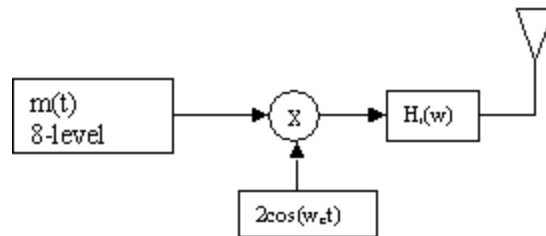

DTV – VSB Modulation

Amplitude-modulating using the signal gives the following spectrum:

How fit into
6 MHz ?

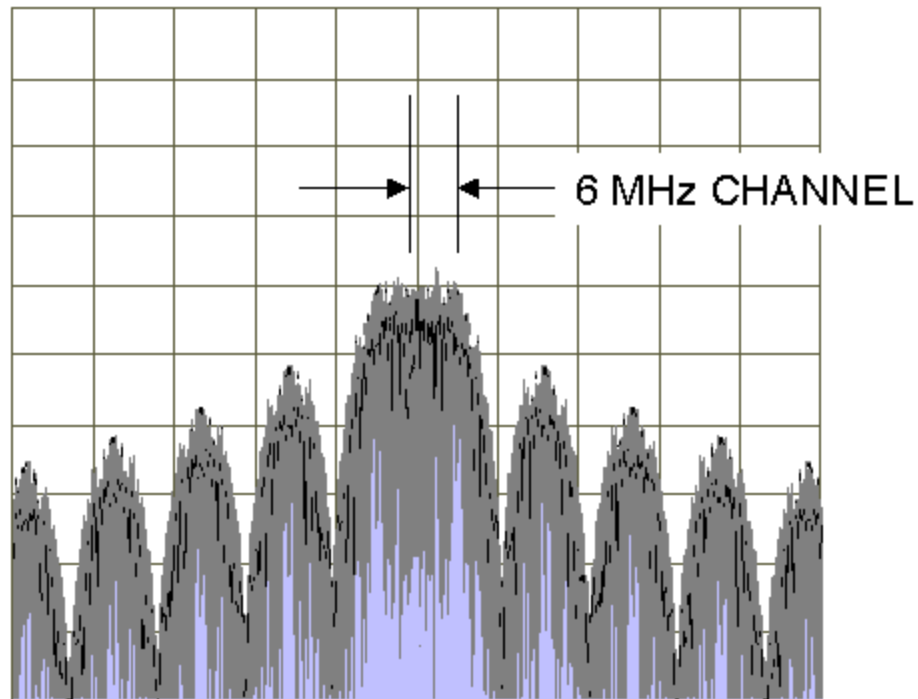

DTV – VSB Modulation

Symbol rate 10,76 MHz

Using Nyquist theorem, sampling rate must be twice the bandwidth (compare Audio CD)

Gives bandwidth of 5,38 MHz

This bandwidth is generated using filtering

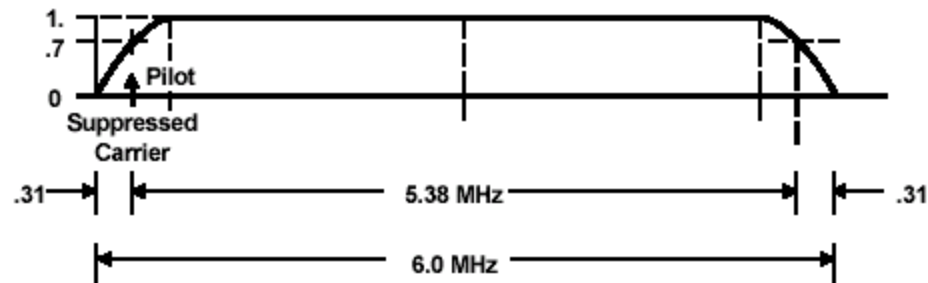

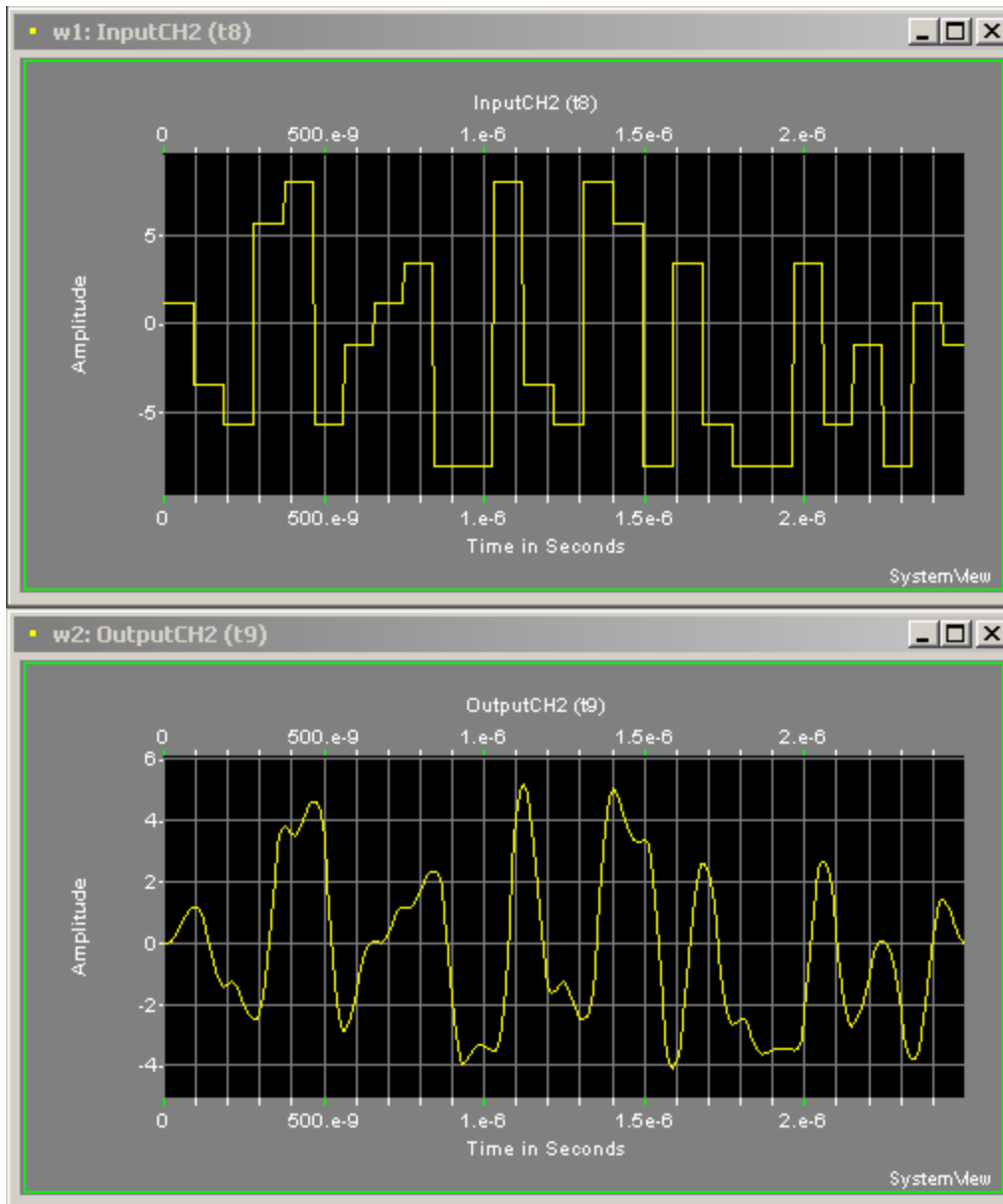

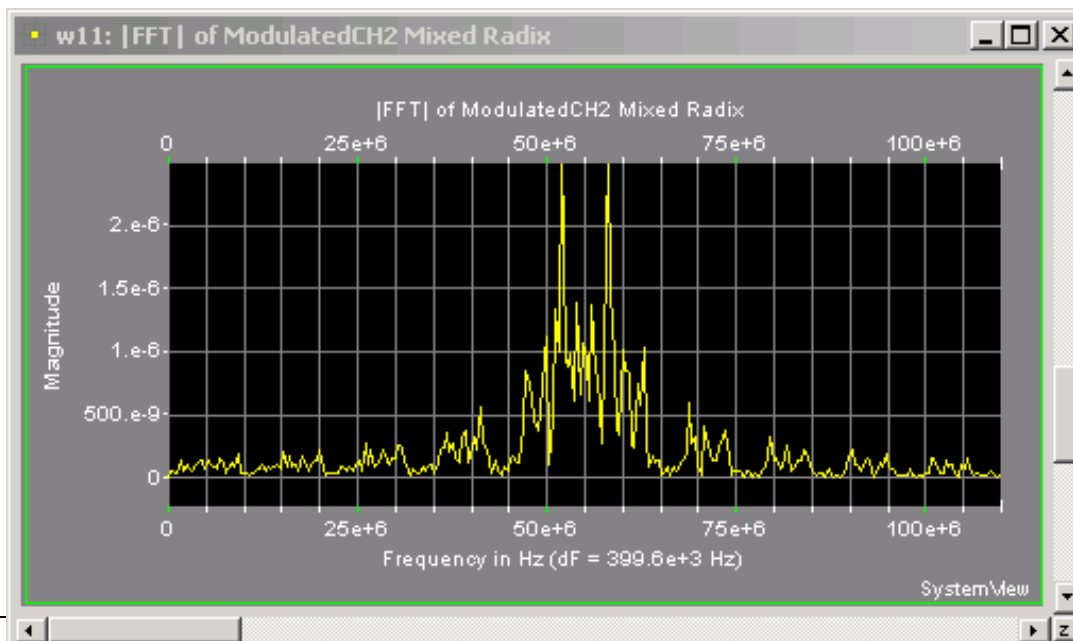
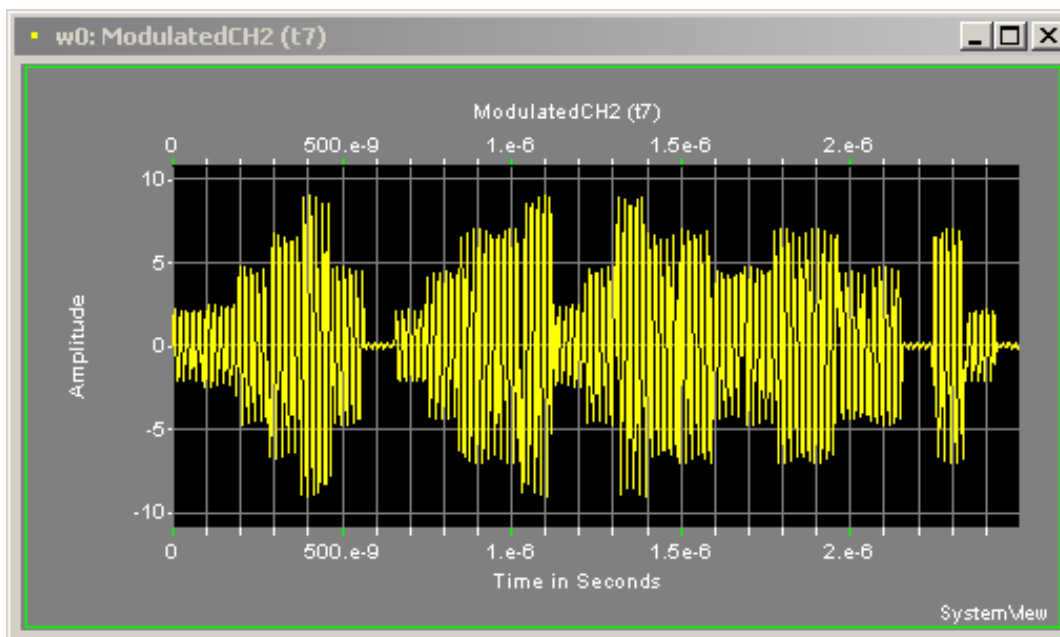

DVB-T to ATSC comparison

No. of carriers	1705 or 6817	1
Modulation	QPSK, 16-QAM, 64-QAM	8-VSB
Hierarchy coding	Yes	No
Outer coding (RS)	8 byte errors	10 byte errors
Inner coding	64 stat conv.	4 state conv.
Conv coding rate	$1/2$, $2/3$, $3/4$, $5/6$, $7/8$	$2/3$
Energy dispersal	15 bit shift, 3 taps	16 bit shift, 9 taps
Bit rate (Mbit/s)	4.98 to 31.7, 8 Mhz	19.4, 6 Mhz
Minimum signal level *	25.2 dB uV	27.2 dB uV
Doppler *	+/- 140 Hz	+/- 1 Hz
Echo correction *	+/- 32 us	+3 to - 20 us

DVB-T to ATSC comparison

Systems	ATSC 8-VSB	DVB-T COFDM	ISDB-T BST-OFDM
Source coding			
Video	Main Profile syntax of ISO/IEC 13818-2 (MPEG-2 - video)		
Audio	ATSC Standard A/52 (Dolby AC-3)	ISO/IEC 13818-2 (MPEG-2 – Layer II audio) and Dolby AC-3	ISO/IEC 13818-7 (MPEG-2 – AAC audio)
Transport Stream	ISO/IEC 13818-1 (MPEG-2 TS) transport stream		
Transmission system			
Channel coding			
Outer coding	R-S (207, 187, t = 10)	R-S (204, 188, t = 8)	
Outer interleaver	52 R-S block interleaver	12 R-S block interleaver	
Inner coding	Rate 2/3 trellis code	Punctured convolutional code: Rate: 1/2, 2/3, 3/4, 5/6, 7/8 Constraint length = 7, Polynomials (octal) = 171, 133	
Inner interleaver	12 to 1 trellis code interleaver	Bit-wise interleaving and frequency interleaving	Bit-wise interleaving, frequency interleaving, and selectable time interleaving
Data randomization	16-bit PRBS	16-bit PRBS	16-bit PRBS
Modulation	8-VSB and 16-VSB	COFDM QPSK, 16QAM and 64QAM Hierarchical modulation: multi-resolution constellation (16QAM and 64 QAM) Guard interval: 1/32, 1/16, 1/8 & 1/4 of OFDM symbol 2 modes: 2k and 8k FFT	BST-OFDM with 13 frequency segments DQPSK, QPSK, 16QAM and 64QAM Hierarchical modulation: choice of three different modulations on each segment Guard interval: 1/32, 1/16, 1/8 & 1/4 of OFDM symbol 3 modes: 2k, 4k and 8k FFT

DVB-T/ATSC C/N

DTTB System	COFDM	8-VSB
Test Rig Beginning (7 MHz)	19.15 dB	14.3-14.4 dB
NEC Tx 180 W	19.3 dB	14.5 dB
Harris Tx 180 W	19.2 dB	14.5 dB
Harris Tx 600/900 W	19.9 dB	14.3 dB
Test Rig End (7 MHz)	19.4-19.6 dB	14.35 dB
Test Rig (6 MHz)	NA	15.1 dB

DVB-T/ATSC Minimum signal

DTTB Conditions	COFDM (dBuV)	8-VSB (dBuV)
Test Rig	25.1	27.2
NEC Tx 200W	25.3	-
Harris Tx 200W	25.2	27.2
Harris Tx 600/900W	25.8	28.25

DVB-T/ATSC Spot parameters

COFDM MOD TYPE	FEC Code Rate	Sys C/N (dB)	Min Sig Level (dBuV)	Calc Rx NF (dB)	Payload Bitrate Mb/s				Lower Adjacent Ch (dB)	Pal C/I Protection		
					Guard 1/4 (Mb/s)	Guard 1/8 (Mb/s)	Guard 1/16 (Mb/s)	Guard 1/32 (Mb/s)		Pal/Cofdm Co Chan Max (dB)	Pal/Cofdm Co Chan Ctr (dB)	Upper Adjacent Ch (dB)
QPSK	1/2	5.4	11.7	4.8	4.35	4.84	5.12	5.28	-44.8	-12.8	-13.0	-49.2
QPSK	2/3	6.6	13.2	5.1	5.81	6.45	6.83	7.04	-44.5	-5.1	-8.4	-47.0
QPSK	3/4	7.6	14.8	5.7	6.53	7.26	7.68	7.92	-43.7	1.1	-4.0	-45.3
QPSK	5/6	8.7	16.8	6.6	7.26	8.06	8.54	8.80	-42.3	5.8	3.1	-43.3
QPSK	7/8	9.5	19.2	8.2	7.62	8.47	8.96	9.24	-40.8	8.0	9.7	-42.0
16-QAM	1/2	11.2	17.7	5.0	8.71	9.68	10.25	10.56	-43.5	-8.0	-8.8	-46.1
16-QAM	2/3	13.0	19.6	5.1	11.61	12.90	13.66	14.07	-42.1	1.1	-2.3	-43.3
16-QAM	3/4	14.1	20.9	5.3	13.06	14.51	15.37	15.83	-40.2	6.0	3.3	-41.2
16-QAM	5/6	15.5	22.9	5.9	14.51	16.13	17.08	17.59	-37.0	11.2	9.9	-39.1
16-QAM	7/8	16.3	24.9	7.1	15.24	16.93	17.93	18.47	-35.2	14.7	16.9	-37.3
64-QAM	1/2	16.8	23.3	5.0	13.06	14.51	15.37	15.83	-41.2	-3.3	-3.1	-41.7
64-QAM	2/3	19.1	25.2	4.6	17.42	19.35	20.49	21.11	-35.4	3.7	1.4	-37.5
64-QAM	3/4	20.6	27.5	5.4	19.59	21.77	23.05	23.75	-35.0	12.0	10.8	-35.9
64-QAM	5/6	22.2	30.0	6.3	21.77	24.19	25.61	26.39	-31.2	18.4	17.1	-33.1
64-QAM	7/8	23.7	32.4	7.2	22.86	25.40	26.89	27.71	-28.9	23.1	22.6	-30.8
8-VSB	2/3	15.1	27.2	11.2	-	-	-	19.39	-38.6	2.6	9.1	-38.7

Blue Payload Figures are 188/204 scaled from actual measurement

Minimum Signal Levels are for 50 Ohms

Red Figures are calculated from the 1/32 Guard interval data

The Yellow Background COFDM 64QAM data indicates the selected modulation type

DVB-T/ATSC Echo

Echo Delay & Type	Echo Level				C/N Threshold (dB)	Rx Level (dBm)
	Guard 1/4 (dB)	Guard 1/8 (dB)	Guard 1/16 (dB)	Guard 1/32 (dB)		
7.48us Post Echo 1st Measure	-0.6	-1.6	-0.8	-4.4	19.3	-45.55
7.48us Pre Echo 1st Measure	-0.7	-1.4	-1.4	-5.1	19.8	-45.55
7.48us Post Echo 2nd Measure	0	0	0	-4.3	19.5	-49.45
7.48us Pre Echo 2nd Measure	0	0	0	-5.3	20.4	-49.45
0 dB C/N Threshold (dB)	32	37	33	-		
5.71us Post Echo	0	-0.6	0	0	19.2	-44.65
5.71us Pre Echo	0	-0.6	0	0	19.3	-44.65
0 dB C/N Threshold (dB)	37	-	40	38		
4.18us Post Echo	0	0	0	0	19.3	-42.15
4.18us Pre Echo	0	0	0	0	19.4	-42.15
0 dB C/N Threshold (dB)	41	40	40	45		
1.71us Post Echo	0	0	0	0	19.3	-42.65
1.71us Pre Echo	0	0	0	0	19.4	-42.65
0 dB C/N Threshold (dB)	39	40	36	39		
0.38us Post Echo	0	0	0	0	19.3	-37.8
0.38us Pre Echo	0	0	0	0	19.3	-37.8
0 dB C/N Threshold (dB)	36	36	37	37		

Echo Delay & Type	8VSB Echo (dB)	C/N Threshold (dB)	Rx Level (dBm)	Relock Level (dB)
7.48us Post Echo	-2.2 & -3.1	14.4	-46.7	-4.2
7.48us Pre Echo	-13.5	14.8	-46.7	
5.705us Post Echo	-2.1	14.4	-42.8	
5.705us Pre Echo	-13.8	14.8	-42.8	
4.18us Post Echo	-4.4 & -2.0	14.4	-38.9	-4.4
4.18us Pre Echo	-13.8	14.6	-38.9	
1.705us Post Echo	-2.0 & -0.6	14.5	-33.7	-6.0
1.705us Pre Echo	-7.1 & -7.0	14.5	-33.7	
0.38us Post Echo	-0.8 & -1.3	14.5	-45.1	
0.38us Pre Echo	-1.8 & -1.8	14.6	-45.1	

Figure 3.9.1 - C/N Threshold vs Echo Level for COFDM 64-QAM 2/3 FEC 1/8 Guard & 8-VSB

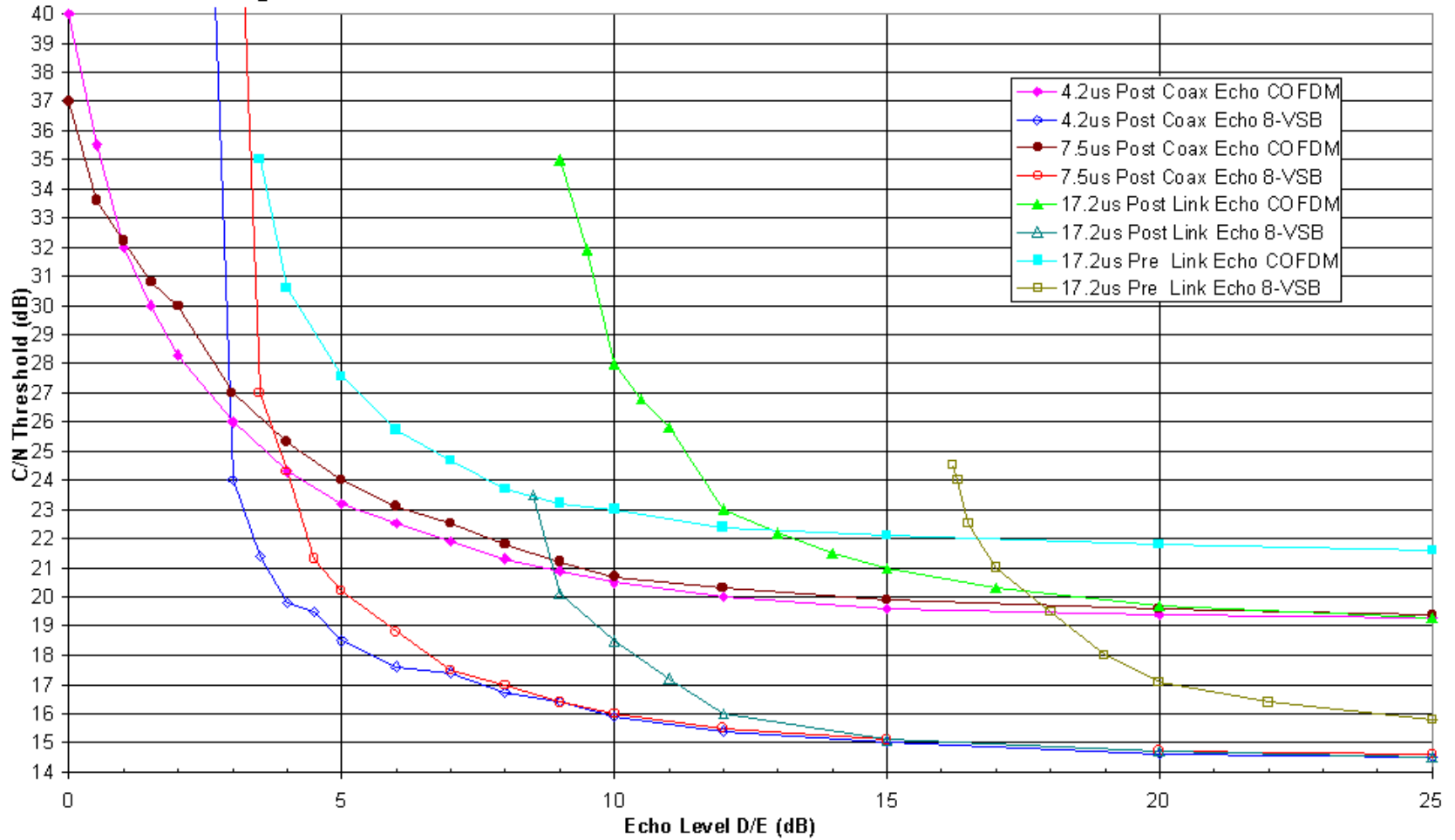

Figure 3.17.1 - BER vs Signal Level for COFDM and 8-VSB

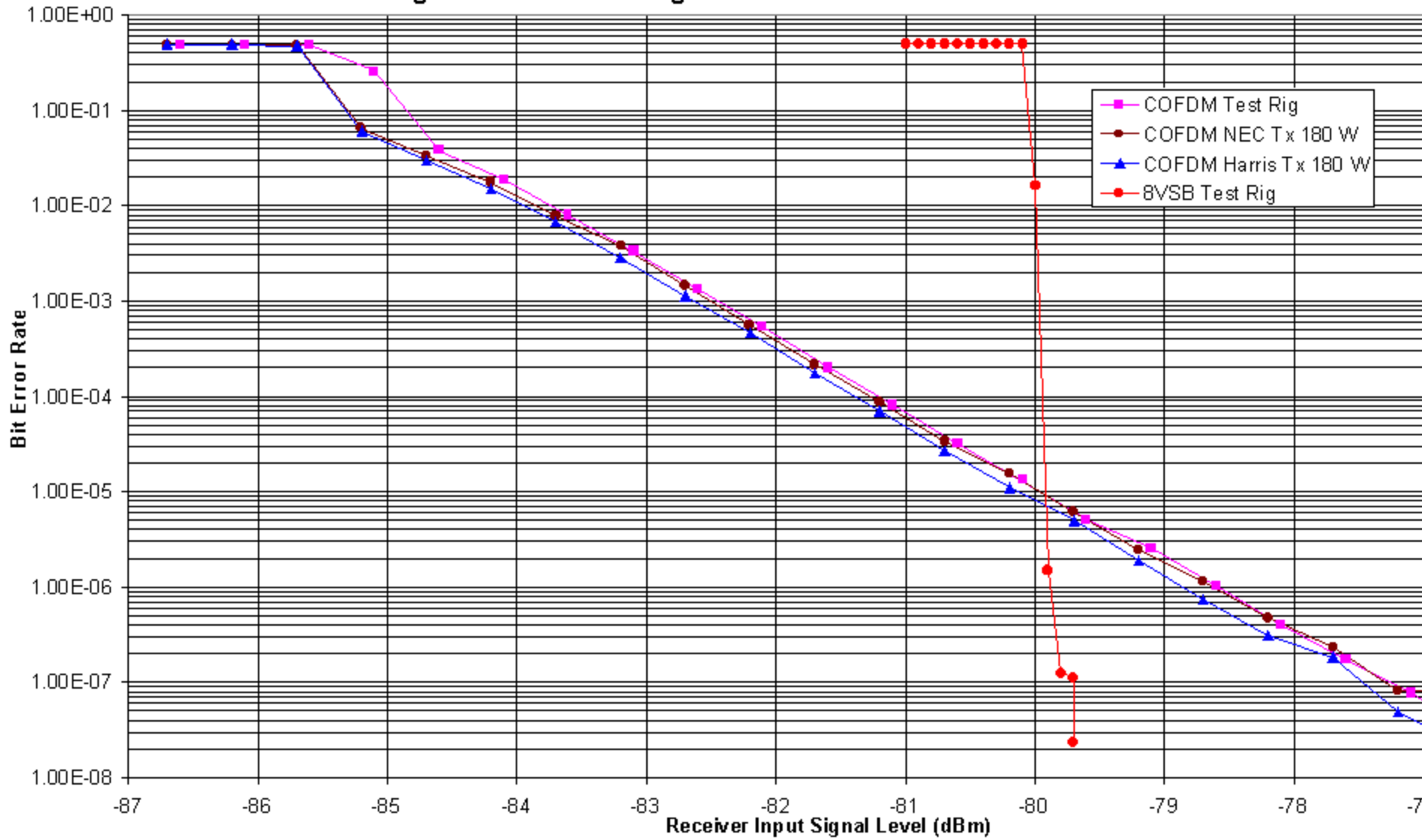

Figure 3.18.1 - BER vs Carrier to Noise for COFDM 64-QAM 2/3 FEC System Software V1

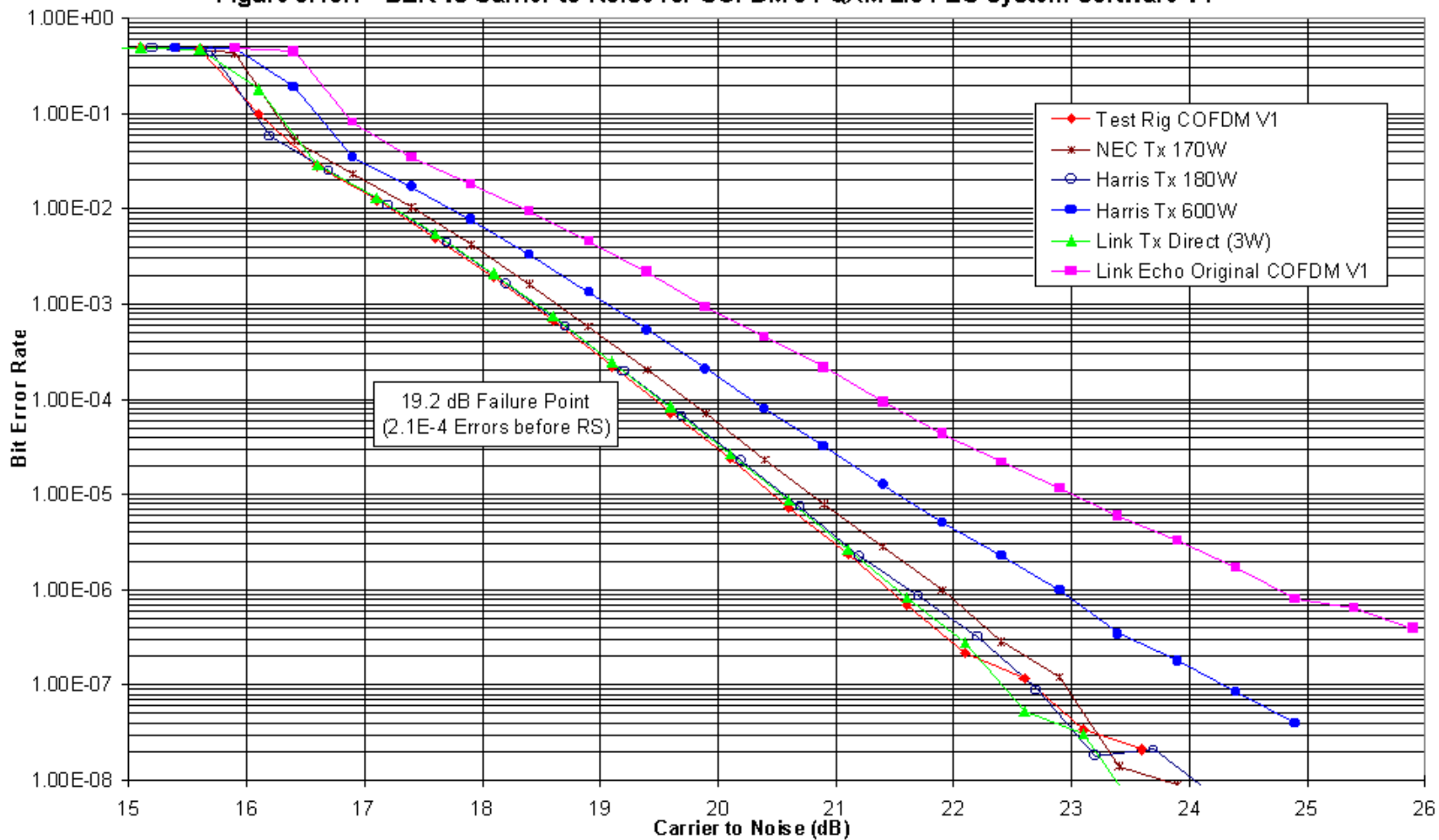

Figure 3.19.1 - C/N Threshold vs Minimum Receiver Level for COFDM 1/8 Guard Interval & 8-VSB

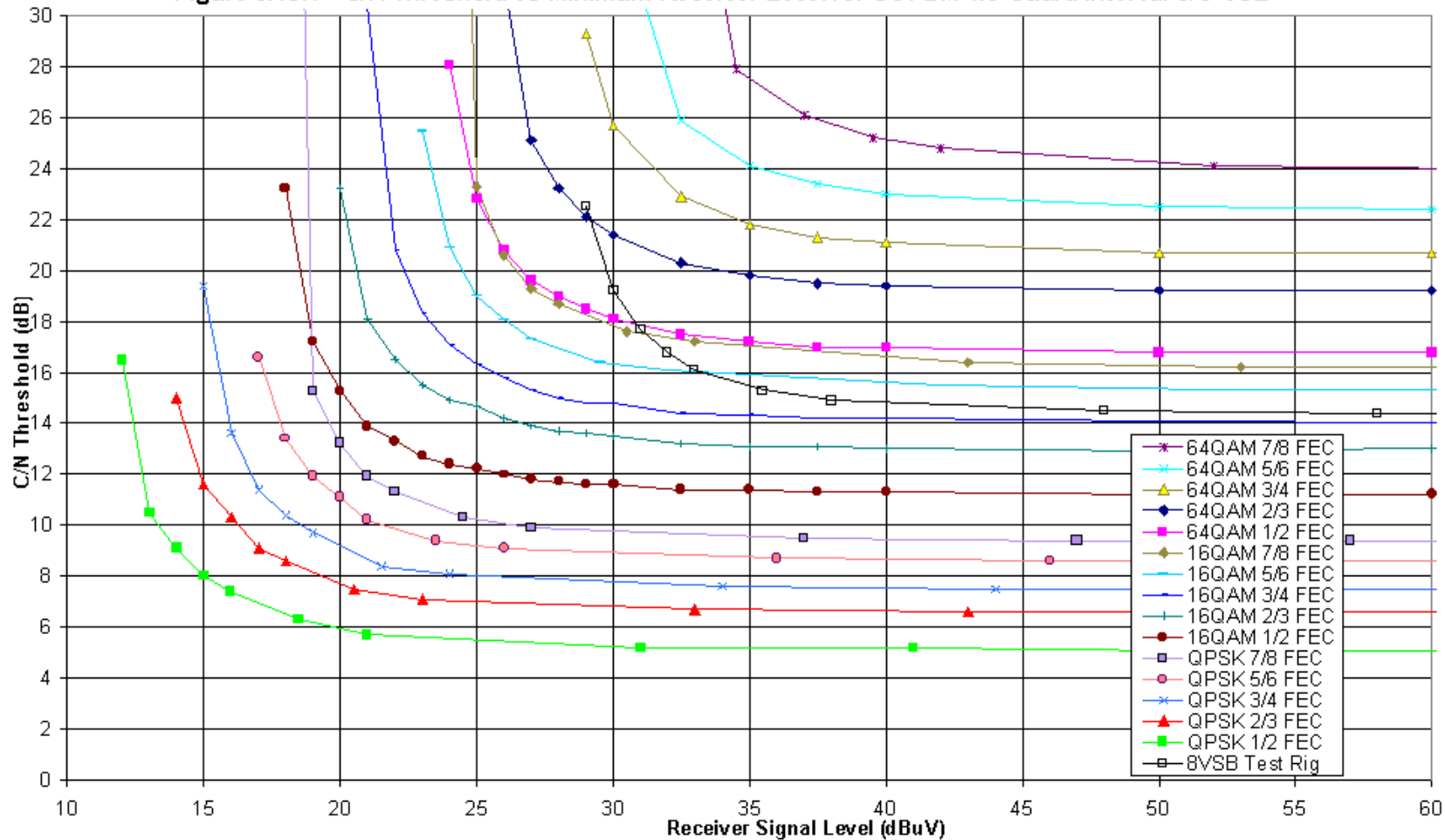
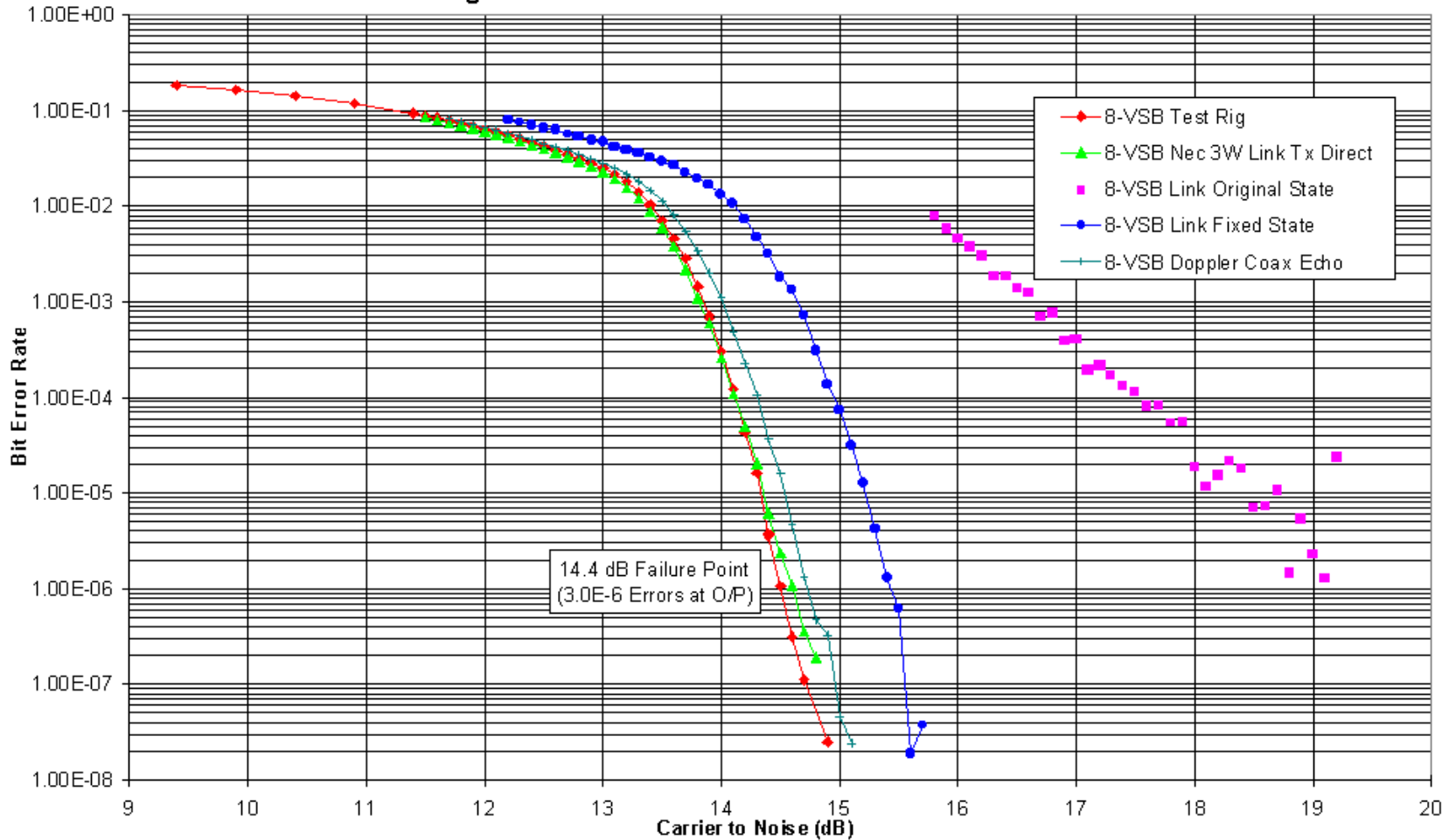

Figure 3.18.3 - BER vs Carrier to Noise for 8VSB



Parameter	COFDM	8-VSB	Section
C/N Threshold in Native System Bandwidth	19.1 dB	15.1 dB	3.5
C/N Threshold Measured as 7 MHz a Channel	19.1 dB	14.3 dB	3.5
Minimum Receiver Signal Level	25.1 dBuV	27.2 dBuV	3.6
Calculated Apparent Noise Figure	4.6 dB	11.3 dB	3.7
Payload Data Capacity	19.35 Mb/s	19.39 Mb/s	3.7
DTTB into PAL Co-Channel Protection LOP	50.5 dB	51.2 dB	3.2
DTTB into PAL Co-Channel Protection SCM40	41.1 dB	45.4 dB	3.2
DTTB into PAL Co-Channel Protection SCM30	35.8 dB	38.7 dB	3.2
DTTB into PAL Lower Adjacent Channel Protection LOP	3.5 dB	4.6 dB	3.2
DTTB into PAL Lower Adjacent Channel Protection	-5.3 dB	-1.5 dB	3.2
DTTB into PAL Lower Adjacent Channel Protection	-9.5 dB	-7.7 dB	3.2
DTTB into PAL Upper Adjacent Channel Protection LOP	5.5 dB	5.0 dB	3.2
DTTB into PAL Upper Adjacent Channel Protection	-6.4 dB	-0.9 dB	3.2
DTTB into PAL Upper Adjacent Channel Protection	-10.6 dB	-7.8 dB	3.2
PAL into DTTB Co-Channel Interference	1.4 dB	9.1 dB	3.3,3.7
PAL into DTTB Lower Adjacent Channel Interference	-35.4 dB	-38.6 dB	3.3,3.7
PAL into DTTB Upper Adjacent Channel Interference	-37.5 dB	-38.7 dB	3.3,3.7
CW into DTTB in channel interference range	+6 to -11	+14 to +7	3.4
DTTB into DTTB Co-Channel Hostile Interference	20.4 dB	14.8 dB	3.10
DTTB into DTTB Lower Adjacent Channel Interference	-28.3 dB	-30.4 dB	3.11.1
DTTB into DTTB Upper Adjacent Channel Interference	-28.5 dB	-32.2 dB	3.11.2
Impulse Noise Performance (Differential to PAL Grade 4)	9-14 dB	17-25 dB	3.12
7.5 us Coax Static Post Echo Level	0 dB	-2.2 dB	3.8.1
7.5 us Coax Static Pre Echo Level	0 dB	-13.5 dB	3.8.1
17.2 us Link Static Post Echo Level	-8 dB	-8.4	3.8.2
17.2 us Link Static Pre Echo Level	-3 dB	-16.2	3.8.2
Sensitivity to IF Translator Performance	Low	High	3.8.2,3.2
Echo Level for 1 dB change in C/N Threshold - Coax	-11 dB	-12 dB	3.9
Echo Level for 1 dB change in C/N Threshold - Link	-17 dB	-14 dB	3.9
Static Doppler Post Echo Performance (-3 dB about peak)	± 140 Hz	± 1 Hz	3.13
Typical DTTB Shoulder Level for 200 W Transmitter	34-39 dB	39-41 dB	3.16
Receiver Signal Level where C/N Threshold Degrades 1 dB	34 dBuV	35 dBuV	3.19
Off Air PAL Ch 7 & 9 into DTTB protection	-36.3 dB	-34.4 dB	3.22
Estimated Receiver IF Bandwidth	7.1 MHz	6.0 MHz	3.22
AFC relock range	11.5 kHz	359 kHz	3.23
Tuning Offset Steps	8 x 200 kHz	16 x 250 kHz	3.24
Modulation IF Frequency	35.8 MHz	44.0 MHz	3.29
Modulated IF Bandwidth	6.7 MHz	5.5 MHz	3.29

